

TJC20074 型条形连接器

TJC20074 Bar Connector

间距 (space) :2.0mm



技术参数 (SPECIFICATIONS)

- 适用线规 (Applicable wires) : AWG#22~AWG#24
- 适应基板厚度 (Applicable PC board thickness) : 1.2 ~ 1.6 mm
- 温度范围 (Temperature range) : -40°C~105°C
- 额定电压 (Voltage rating) : 60V AC/DC
- 额定电流 (Current rating) : 3A
- 接触电阻 (Contact resistance) : $\leq 0.025\Omega$
- 绝缘电阻 (Insulation resistance) : $\geq 100M\Omega$
- 耐压 (Withstand voltage) : 500V AC/minute

端子 TERMINAL

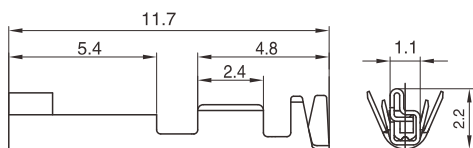

型号 Type	适用导线范围 Wire Range		导线外径(mm) Wire ins.Dis
	mm ²	AWG#	
CH-TJC20074	0.35	22	1.2
CH-TJC20074-1	0.22	24	1.0
材质·表面处理 Material and Finish			
铜合金镀锡 Copper alloy Tin·Plated			

阴连接器 HOUSING

TJC20074-2xnY ASSY

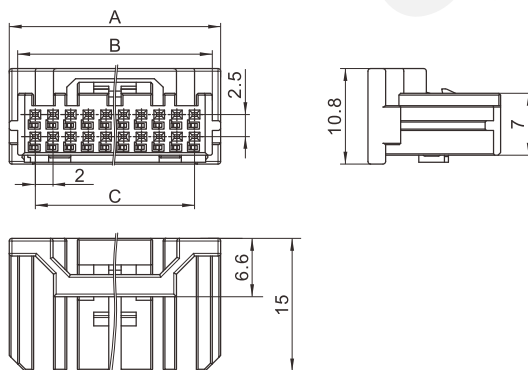

TJC20074-2xnY-1 ASSY

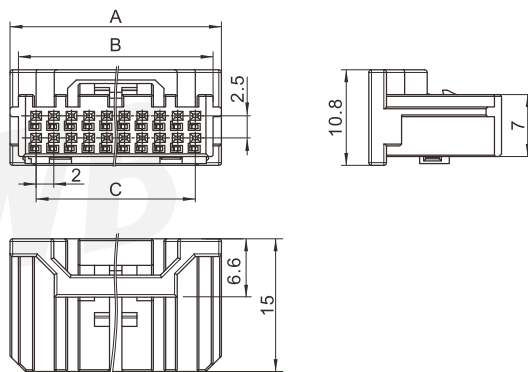

TJC20074 型条形连接器

TJC20074 Bar Connector

间距 (space) :2.0mm

键位 Key	线数 Poles	型号 Type	尺寸 Dimensions (mm)		
			A	B	C
A	8	TJC20074-2 × 4Y-1 Assy	11.9	10	6
	12	TJC20074-2 × 6Y-1 Assy	15.9	14	10
	16	TJC20074-2 × 8Y-1 Assy	19.9	18	14
	20	TJC20074-2 × 10Y-1 Assy	23.9	22	18
	24	TJC20074-2 × 12Y-1 Assy	27.9	26	22
	28	TJC20074-2 × 14Y-1 Assy	31.9	30	26
	32	TJC20074-2 × 16Y-1 Assy	35.9	34	30
	36	TJC20074-2 × 18Y-1 Assy	39.9	38	34
B	40	TJC20074-2 × 20Y-1 Assy	43.9	42	38
	8	TJC20074-2 × 4Y Assy	11.9	10	6
	12	TJC20074-2 × 6Y Assy	15.9	14	10
	16	TJC20074-2 × 8Y Assy	19.9	18	14
	20	TJC20074-2 × 10Y Assy	23.9	22	18
	24	TJC20074-2 × 12Y Assy	27.9	26	22
	28	TJC20074-2 × 14Y Assy	31.9	30	26
	32	TJC20074-2 × 16Y Assy	35.9	34	30
36	TJC20074-2 × 18Y Assy	39.9	38	34	
40	TJC20074-2 × 20Y Assy	43.9	42	38	

材质 · Material Socket Housing: PBT UL94V-0
Locking: PA66 UL94 V-0

阳连接器 HEADER (90°)

TJC20074-2xnAWB-1

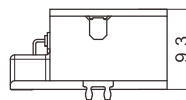
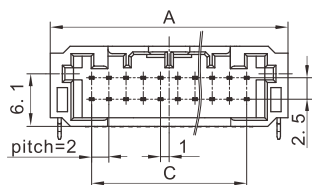
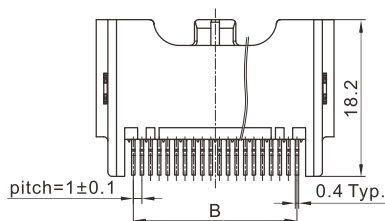

TJC20074-2xnAWB

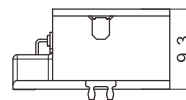
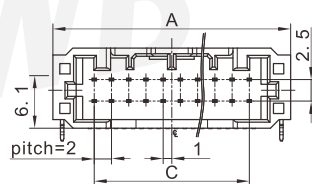
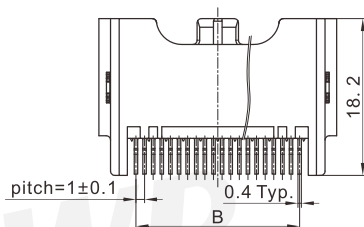

TJC20074 型条形连接器

TJC20074 Bar Connector

间距 (space) :2.0mm

键位 Key	线数 Poles	型号 Type	尺寸 Dimensions (mm)		
			A	B	C
A	8	TJC20074-2 × 4AWB-1	15.6	7	6
	12	TJC20074-2 × 6AWB-1	19.6	11	10
	16	TJC20074-2 × 8AWB-1	23.6	15	14
	20	TJC20074-2 × 10AWB-1	27.6	19	18
	24	TJC20074-2 × 12AWB-1	31.6	23	22
	28	TJC20074-2 × 14AWB-1	35.6	27	26
	32	TJC20074-2 × 16AWB-1	39.6	31	30
	36	TJC20074-2 × 18AWB-1	43.6	35	34
B	8	TJC20074-2 × 4AWB	15.6	7	6
	12	TJC20074-2 × 6AWB	19.6	11	10
	16	TJC20074-2 × 8AWB	23.6	15	14
	20	TJC20074-2 × 10AWB	27.6	19	18
	24	TJC20074-2 × 12AWB	31.6	23	22
	28	TJC20074-2 × 14AWB	35.6	27	26
	32	TJC20074-2 × 16AWB	39.6	31	30
	36	TJC20074-2 × 18AWB	43.6	35	34
	40	TJC20074-2 × 20AWB	47.6	39	38

材质 · 表面处理 Material and Finish PPS UL94V-0
磷青铜镀锡 Phos · bronze Tin · Plated

安装尺寸 MOUNTING MEASUREMENT

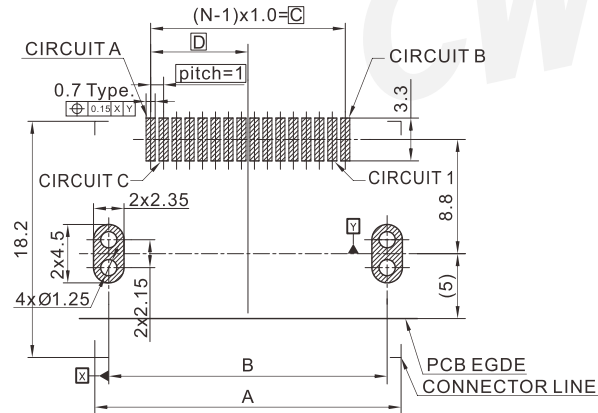

线数 Poles	尺寸 Dimensions (mm)			
	A	B	C	D
8	15.6	13.45	7	3.5
12	19.6	17.45	11	5.5
16	23.6	21.45	15	7.5
20	27.6	25.45	19	9.5
24	31.6	29.45	23	11.5
28	35.6	33.45	27	13.5
32	39.6	37.45	31	15.5
36	43.6	41.45	35	17.5
40	47.6	45.45	39	19.5